

# NUTORK<sup>®</sup>

Actuators & Controls



## Operation Manual Electro-Pneumatic Positioner Model: NT-1000R (Rotary Type)



Integral Mounted Air Set



Dome Indicator

# NUTORK CORPORATION

### Table of Contents

Introduction	2
Manufacturer Warranty	2
Product Description	3
Main Features and Functions	3
Operation Logic	3
Label Description	3
Suffix Symbols	4
Specification	5
Parts and Assembly	6
Dimensions	6
Installation	7
Safety Warning	7
Tools for Installation	7
NT-1000R Installation	7
Using Brackets to Install	8
Connection	11
Connection - Piping	11
Power Connection - Explosion-Proof Type	12
Adjustment	14
Adjustment - Zero Point	14
Adjustment - Span	14
Adjustment - Auto/Manual Switch	15
Adjustment - Seat Adjuster	15
Adjustment - Orifice	16
Maintenance - Pilot Valve	16
Troubleshooting	17

# **NUTORK**®

## **Actuators & Controls**

### **Introduction**

Thank you for choosing NUTORK product. Each product is fully inspected after the production to offer you the highest quality. In order to fully utilize the product, we strongly recommend users to read this manual carefully and understood.

- The manual should be provided to the end user.
- The manual can be changed or revised without any prior notice. Any changes in product's specification, structure, and/or any components may not result immediate revised version of the manual.
- The manual should not be duplicated or reproduced for any purpose without any approval from NUTORK CORP.

### **Manufacturer Warranty**

- For the safety, it is imperative to follow instructions in the manual. It is not manufacturer's liability for any damages which caused by users' negligences.
- It is not manufacturer's liability for any damages or accidents which resulted by any alteration or modification of the product and parts. If alteration or modification is necessary, please contact the manufacturer directly.
- Manufacturer warrants the product from the date of original retail purchase of the product for one (1) year, except as otherwise stated.
- Manufacturer warranty will not cover the products that the product have been subjected to abuse, accident, alteration, modification, tampering, negligence, misuse, faulty installation, lack of reasonable care, repair or service in any way that is not contemplated in the documentation for the product, or if the model or serial number has been altered, tampered with, defaced or removed; damages that occurs in shipment, due to act of God, failure due to power surge, and cosmetic damage. Improper or incorrectly performed maintenance or report voids this Limited Warranty.

### Product Description

#### Main Features and Functions

- It is designed for high durability and performance in high vibration environment.
- Durability has proven after testing of 1 million times minimum.
- Response time is very short and accurate.
- Simple part change can set 1/2 Split Range.
- It is economical due to less air-consumption.
- Direct/Reverse action can be set easily.
- Zero & Span adjustment process is simply.
- Feedback Connection is easy.

#### Operation Logic

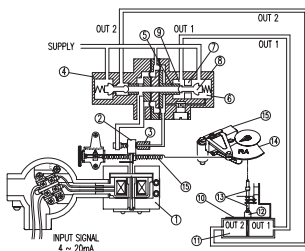

<Figure 1>

If supply pressure increased, Flapper ( ) gets pushed by the force from torque-motor ( ). As the gap between flapper ( ) and the nozzle ( ) increases, air pressure exhausts from pilot valve ( ) and upper spool ( ). As a result, spool ( ) rises. Then the air pressure will be supplied to the actuator ( ). As actuator ( ) moves, the cam (14) receives the movement. This movement pulls the span spring (15). <Figure 1>

#### Label Description

NUTORK® E/P POSITIONER	
Actuators & Controls	CE 0344 EN 2 G JIS
MODEL NUMBER	NT-1000
EXPLOSION PROOF	Ex md IIB T5 NEMA 03ATEX1195 / CSA 05 1613814
INPUT SIGNAL	4 ~ 20mA DC (Max. Prospective Ipc=300A)
AMBIENT TEMP.	-20°C to 60°C
SUPPLY PRESSURE	1.4 ~ 7 kgf/cm <sup>2</sup> (External Fuse ≤ 62mA)
SERIAL NUMBER	

NUTORK® E/P POSITIONER	
Actuators & Controls	CE 0344 EN 2 G JIS
MODEL NUMBER	NT-1000
EXPLOSION PROOF	Ex ia IIB T6
INPUT SIGNAL	4 ~ 20mA DC
AMBIENT TEMP.	-20°C to 120°C
SUPPLY PRESSURE	1.4 ~ 7 kgf/cm <sup>2</sup>
SERIAL NUMBER	

Model Number:	Indicates model name and any options (if any).
Explosion Proof:	Indicates explosion proof grade.
Input Signal:	Indicates current input signal range.
Ambient Temperature:	Indicates ambient temperature for normal operation.
Supply Pressure:	Indicates the range of supply pressure.
Serial Number:	Indicates unique serial number.

### Suffix Symbol

NT-1000R series follows suffix symbols as follows.

### NT-1000R ① ② ③ ④ ⑤ ⑥ ⑦ ⑧ ⑨

① Motion Type	S : Single D : Double
② Explosion Proof	m : ExdmIIBT5 C : ExdmIICT5 i : ExialIIBT6 or ExialIICT6(NEPSI) n : Non-Explosion
③ Feedback Lever	1 : M6X40L 2 : M6X63L 3 : M8X40L 4 : M8X63L 5 : NAMUR
④ Orifice	1 : Ø1 2 : Ø2 3 : None
⑤ Connection Type	1 : PT 2 : NPT
⑥ Ambient Temperature	S : -20 ~ 70℃ H : -20 ~ 120℃ L : -40 ~ 70℃
⑦ Option 1	0 : Standard 1 : Dome Indicator
⑧ Option 2	0 : None 1 : + PTM Internal 2 : + PTM External (explosion proof) 3 : + L/S Internal 4 : + L/S External (explosion proof) 5 : + PTM + L/S Internal 6 : + PTM + L/S External (explosion proof)

\* For special specification, please contact our sales department.

# NUTORK®

## Actuators & Controls

### Specification

Category		NT-1000R	
		Single	Single
Input Signal		4~20mA DC*1	
Impedance		250±15Ω	
Supply Pressure		1.4~7.0kgf/cm <sup>2</sup> (20~100 psi)	
Stroke		0~90° *2	
Air Connection		PT(NPT) 1/4	
Gauge Connection		PT(NPT) 1/8	
Conduit Entry		PF 1/2 or G 1/2	
Explosion Proof*3		<b>Domestic</b> : ExdmIIBT5, ExdmIICT5, ExialIBT6 <b>ATEX</b> : EExmdIIBT5, <b>JIS</b> : ExsdIIBT5 <b>CSA</b> : ExmdIIBT5, <b>NEPSI</b> : ExialIICT6	
Protection		IP66	
Ambient Temperature	Operating	Standard: -20~70°C, Low: -40~70°C High: -20~120°C	
	Explosion	-20~60°C(T5), -20~40°C(T6)	
Linearity		±1.0% F.S	
Hysteresis		1.0% F.S	
Sensitivity		±0.2% F.S	±0.5% F.S
Repeatability		±0.5% F.S	
Air Consumption		3LPM (Sup=1.4kgf/cm <sup>2</sup> ,20psi)	
Flow Capacity		80LPM (Sup=1.4kgf/cm <sup>2</sup> ,20psi)	
Material		Aluminum Diecasting	
Weight		2.7kg(6.1lb)	

\* Tested under ambient temperature of 20°C, absolute pressure of 760mmHg, and humidity of 65%. Please contact us for more detailed specification.

\*1: For 1/2 Split Control, it can be applied by adjusting zero and span.

\*2: For inquiry regarding strokes under 10mm or above 150mm, please contact NUTORK.

\*3: NT-1000R has different types of explosion proof certificates. Please make sure to check explosion proof grade.

# NUTORK<sup>®</sup>

## Actuators & Controls

### Parts and Assembly

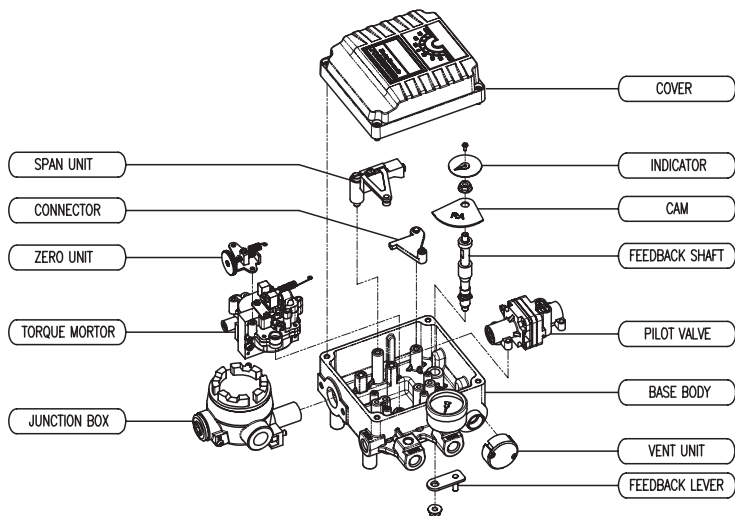

### Dimensions

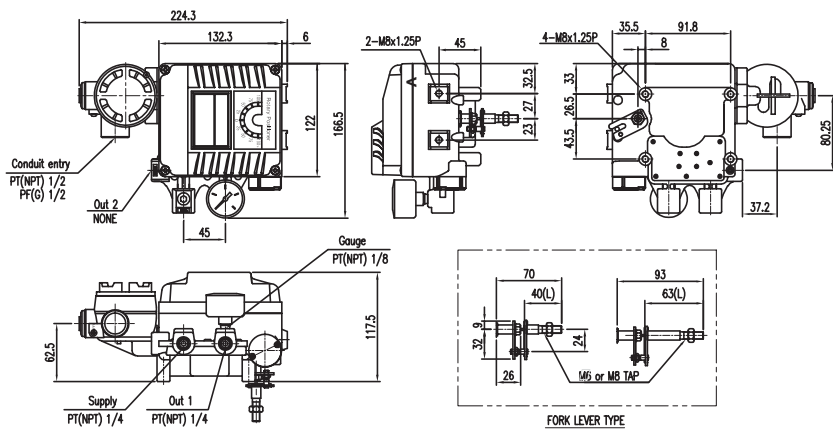

Explosion-proof type NT-1000R

# NUTORK®

## Actuators & Controls

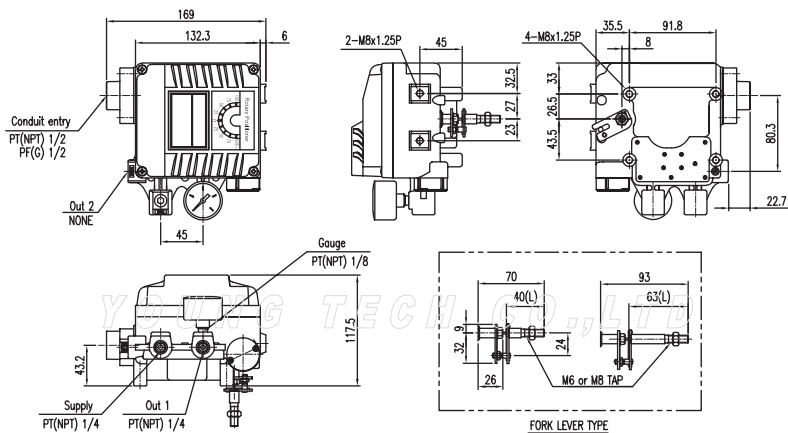

### Intrinsically safe type NT-1000R

## Installation

### Safety Warning

When installing positioner, please ensure to read and follow safety instruction.

- All input and supply pressure to valve, actuator, and other related devices must be turned off.
- Use bypass valve or other equipment to avoid entire system "shut down."
- Make sure there is no remaining pressure in the actuator.

### Tools for installation

- ① Hexagonal wrench
- ② Screw drivers (+) & (-)
- ③ Spanners for hexagonal-head bolts

### NT-1000R installation

NT-1000R should be installed on rotary motion valve such as ball valve or butterfly valve using spring return type diaphragm or piston actuator. Before installation, be sure to check for following installation components.

- ① NT-1000R main body
- ② Feedback lever and lever spring
- ③ Flange nut (bottom side of NT-1000L)
- ④ 4 pcs. of hexagon head bolts (M8 X 1.25P)
- ⑤ 4 pcs. of M8 plate washer



- 2) Attach bracketed NT-1000R to the actuator by using hexagon-headed and wrench bolts. Size of the bracket hole is 6mm. When tightening bolts, use spring washer or similar for firm attachment to the actuator, so NT-1000R will not shake by vibration or any other impact. The direction of bracket is different by the operating condition, but normally, the positioner is installed as shown in <Figure 6>.

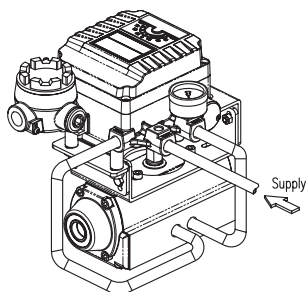

<Figure 6 >

- 3) Set rotation position of the actuator stem at zero point, "0%". For a single type of actuator, it is easy to check zero point, because the actuator stem is positioned at zero point when there is no supply pressure. If double acting actuator is used, check actuator stem's rotation direction (clockwise or counter-clockwise) by supplying pressure.
- 4) Install the fork lever as shown in <Figure 7> after setting actuator stem at zero point. Check the direction of the actuator stem - clockwise or counter-clockwise. Installation angle of the fork lever should be 45 degrees based on the linear shaft. For NAMUR shaft, the angle does not matter.

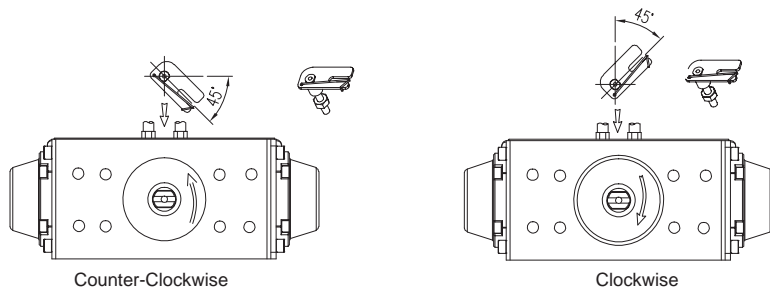
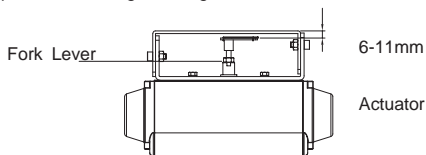

Figure 7

# NUTORK<sup>®</sup>

## Actuators & Controls

- 5) After setting fork lever position, lock nuts which are assembled on the bottom of the fork lever. Make sure to set upper height of the fork lever between 6-11mm, which is lower than upper bracket height. <Figure 8>



<Figure 8>

- 6) Attach NT-1000R to the bracket. Fix the clamping pin on the main shaft's center of NT-1000R and insert connection bar into the fork lever slot, so it can be locked to the fork lever spring. This sets the alignment of the main shaft of NT-1000R and center of the actuator stem. Bad alignment of the main shaft and the actuator stem lowers NT-1000R's durability, because too much force will be on the main shaft of NT-1000R. <Figure 9>

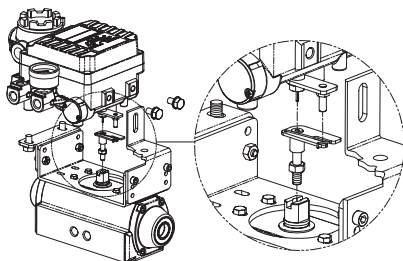

<Figure 9>

- 7) Tighten NT-1000R base and the bracket with hexagon-headed bolts and plate washer. It is recommended to tighten four bolts after checking NT-1000R's position. <Figure 10>

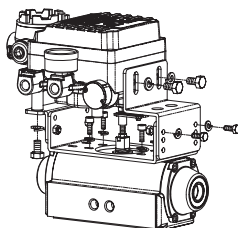

<Figure 10>

# NUTORK<sup>®</sup>

## Actuators & Controls

### Connection

#### Connection - Piping

##### Note

- To avoid entering moisture, oil, or dust into the product, please carefully make selection of supply pressure compressor.
- It is recommended to attach air filter regulator before supply port of NT-1000R.

##### Supply Pressure Condition

- ① Dry air with at least 10 lower than ambient temperature.
- ② Avoid from dusty air. Filter can only sort 5 micron or larger.
- ③ Avoid any oil.
- ④ Comply with ANSI/ISA-57.3 1975(R1981) or ISA S7.3-1975(R1981).
- ⑤ Not to be used beyond the range of 1.4 - 7 kgf/cm<sup>2</sup>(140 - 700 kPa).
- ⑥ Set air filter regulator's supplied pressure 10% higher than actuator's spring range pressure.

##### Pipe Connection

- ① Make sure inside of pipe is emptied.
- ② Do not use pipeline that is squeezed or has hole.
- ③ To maintain flow rate, use the pipeline that has more than 6mm inner diameter. (10mm outer diameter)
- ④ Do not use extremely long pipeline system. It may affect flow rate due to the friction inside of the pipeline.

#### Piping Connection with Actuator

##### Single acting actuator

NT-1000 series single acting type is set to use OUT1 port. OUT1 port should be connected with supply pressure port from actuator when using single acting type of spring return actuator. <Figure 11>

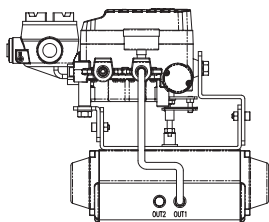

<Figure 11>

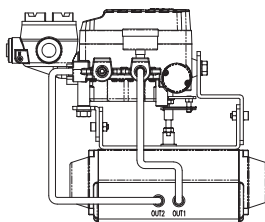

<Figure 12>

### Double acting actuator

For NT-1000 series double acting type, when inputting current signal, supply pressure is out from OUT1. Please refer to <Figure 12>

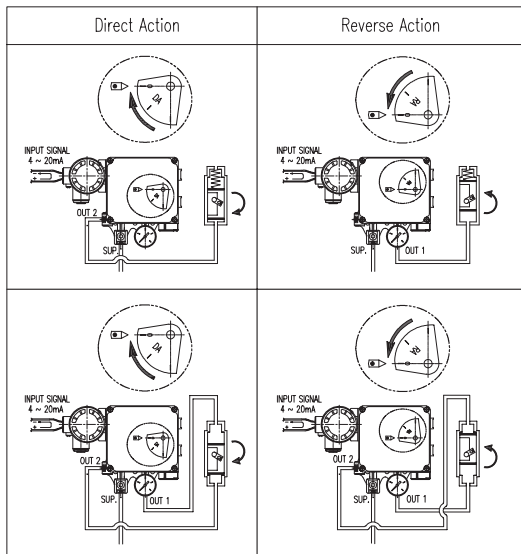

<Figure 13: Cam adjustment and piping connection>

## Power Connection - Explosion-Proof Type

### Connection - Connection Port

- (1) Connection port size is PF1/2 or G1/2.
- (2) Make sure that the fastener bolts is tightly fastened.
- (3) Make sure to seal tightly on the connection port, and there is no leak.
- (4) When connecting explosion-proof type terminal, the number of thread must be at least six and has to be water-proof. <Figure 14>

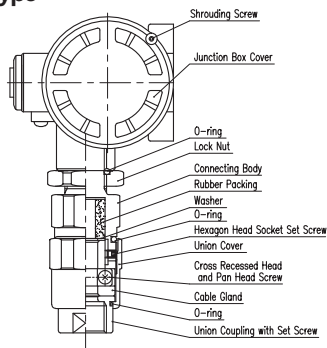

<Figure 14>

### Connection - Cable Gland

- ① Use certified explosion proof products.
- ② End of cable must be crimp style terminal. Please refer to below table. <Figure 15>

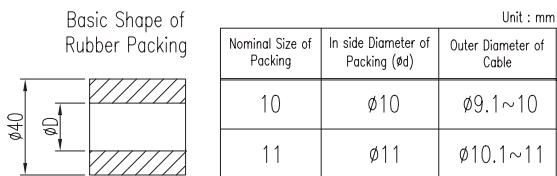

<Figure 15>

- ③ Insert the terminal connection into terminal box and lock completely.
- ④ Insert washer and rubber packing, and fasten the cable gland completely.
- ⑤ Fasten the clamp, then Union Grouping and Union Cover. <Figure 14>

### Connection - Power

- ① Open terminal box cover.
- ② Locate the poles and connect them properly.  
Make sure to fasten the connection.
- ③ Close back the terminal box cover. <Figure 16>

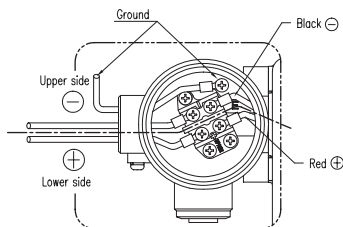

<Figure 16>

### Safety Warning

NT-1000R designed under intrinsically safe procedures and restriction. However, intrinsically safe system can be damaged from electronic energies from other electronic devices. To avoid any system damages, please read the following.

- Differentiate intrinsically safe type circuit with other types of circuit clearly.
- Apply proper protection device to reduce frictions.
- If possible, minimize the use of inductance and capacitance. If they must be used, set the devices at lower level than the maximum level.
- Protect the wires from damages.
- Grounding must be done properly according to the field's procedures.

### Connection - Ground

- ① Open positioner's body cover.
- ② Locate the poles and connect them properly. <Figure 17>

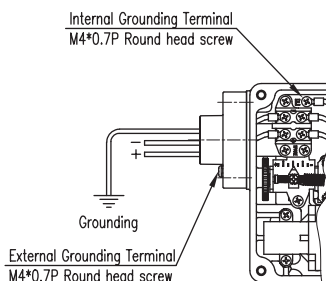

<Figure 17>

### Adjustment

#### Adjustment - Zero Point

- ① Set supply signal at 4mA or 20mA and rotate adjuster clockwise or counter-clockwise to adjust actuator's initial point. When setting initial point, the specification of valve and system must be taken account. Please refer to <Figure 18> for increase/decrease of the zero point.

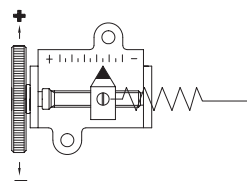

<Figure 18>

- ② When single acting actuator with spring is used, please check if the pressure level which is indicated on the positioner is same to the supplied pressure level.

#### Adjustment - Span

- ① After setting zero, supply 20mA or 4mA of signal. Check the actuator's stroke. If the stroke is too low, adjust the span towards '+' direction. On the other hand, if the stroke is too high, adjust the span towards '-' direction. <Figure 19>
- ② Changing span point affects zero point setting. So zero setting must be set again. After setting zero point, confirm the span point. This step must be repeated until both points are properly set.
- ③ After setting is completed, tighten Lock Screw. <Figure 19>

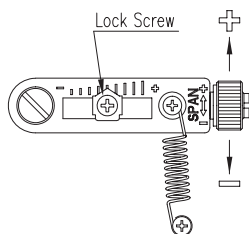

<Figure 19>

### Adjustment - A/M Switch (Auto/Manual)

- ① A/M switch adjusts the valve operation to automatic or manual.
- ② When produced, NT-1000R is set at "A(Automatic)". If user prefers the positioner's setting as "M(Manual)," the setting can be changed by turning the switch counter-clockwise. <Figure 20>

If it is set as "M(Manual)", the air pressure will be supplied to the actuator directly. Always set back to "A(Automatic)" after setting change.

- ④ If OUT2 in single acting actuator or double acting actuator is used, A/M Switch will not operate.

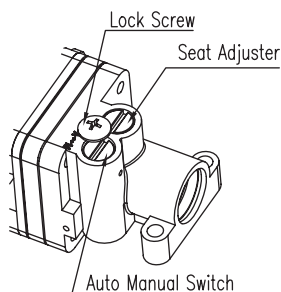

<Figure 20>

### Adjustment - Seat Adjuster

- ① Seat Adjuster is set according to the customer's request before the positioner is delivered. Please do not adjust the Seat Adjuster.
- ② Seat Adjuster is used for double acting actuator always and adjusted when the pressure balance point must be changed. Please do not touch the Seat Adjuster, because it can affect the positioner's performance. <Figure 21>

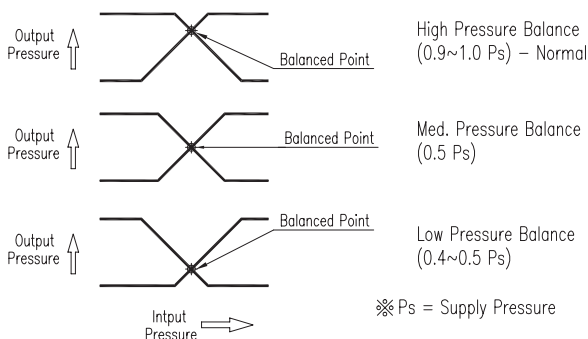

<Figure 21>

### Adjustment - Orifice

- ① If the size of actuator is too small relative to the flow rate, positioner can have hunting. In order to avoid hunting, orifice can be used. There are three types of the orifice.

Actuator Size	Orifice Size	Suffix Symbol
90 cm <sup>3</sup> less	Φ1	1
90 ~ 180 cm <sup>3</sup>	Φ2	2
180 cm <sup>3</sup> more	none	3

- ② Remove the o-ring from OUT1 and OUT2 port and insert appropriate orifice. After inserting orifice, place back the o-ring. Make sure there is no substance entering into port. <Figure 22>
- ③ If hunting persists after inserting the orifice, please contact NUTORK or its appropriate agent.

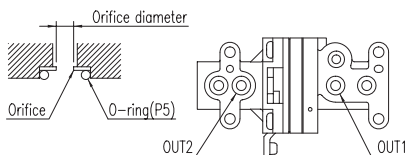

<Figure 22>

### Maintenance - Pilot Valve

Maintenance should be performed on Pilot Valve Relay at least once a year. When disassembling the pilot valve relay, please do make sure not to lose o-ring or stabilizer spring. Please refer to <Figure 23> for the instruction.

- (1) Remove stopper bolts.
- (2) Unlock the Auto/Manual Switch.
- (3) Remove if there is any blocking within the port and orifice.

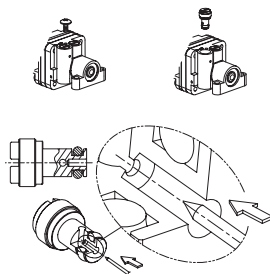

<Figure 23>



### TROUBLESHOOTING

#### **Positioner does not respond to the input signal.**

- (4) Check supply pressure level. The lever must be at least 1.4 kgf/cm<sup>2</sup>. For spring-return type of actuator, the supply pressure level has to be larger than the spring's specification.
- (5) Check if input signal is properly supplied to the positioner. The signal should be 4~20mA DC.
- (6) Check if zero point or span point is properly set.
- (7) Check if the positioner's nozzle has been blocked. Also, check if the pressure is supplied to the positioner and the pressure is being exhausted through the nozzle. If the nozzle has been blocked by any substances, please send the product for repair.
- (8) Check if feedback lever has been installed properly.

#### **The pressure of OUT1 reaches exhausting pressure level and does not come back down.**

- (1) Check A/M Switch. If the switch has been damaged, replace the switch or pilot relay valve.
- (2) Check for a gap or damages between the nozzle and the flapper. If damaged, please send the product to NUTORK for repair.

#### **The pressure is exhausted only by A/M Switch.**

- (1) Check if the positioner's nozzle has been blocked. Also, check if the pressure is supplied to the positioner and the pressure is being exhausted through the nozzle. If the nozzle has been blocked by any substances, please send the product to NUTORK for repair.

#### **Hunting occurs.**

- (1) Check if safety spring has been displaced. (Next to Pilot relay valve)
- (2) Check if the size of actuator is too small. If so, insert an orifice in order to reduce the pressure flow rate.
- (3) Check if there is any friction between the valve and the actuator. If so, increase actuator's size or reduce the friction level.

#### **Actuator only operates by On/Off.**

- (1) Check actuator and positioner's acting type. Air pressure exhausts from NT-1000L's OUT1 port as input signal level increases. Therefore, it is standard to connect to OUT1 port when single actuator is used. Make sure the span adjustment is properly set according to the valve system.

#### **Linearity is too low.**

- (1) Check if positioner is properly positioned. Especially check if the feedback lever is parallel to the ground at 50% point.
- (2) Check if zero and span point have been properly adjusted. If either one of values is being adjusted, another one must be re-adjusted as well.
- (3) Check if supply air pressure level is stable from the regulator. If the level is

unstable, the regulator must be replaced.

### **Hysteresis is too low.**

- (1) In case of double acting actuator, check if seat adjustment has been properly performed. Please contact NUTORK for any further inquiries regarding the seat adjustment.
- (2) Backlash can occur when the feedback lever and lever spring are loosen.  
To avoid backlash, please adjust the lever spring.
- (3) Check if the connection bar to the feedback lever is tightly fastened.



# NUTORK<sup>®</sup>

## Actuators & Controls

**NUTORK CORP.** manufactures a wide range of pneumatic actuators, electric actuators and the accessories of pneumatic actuator (limit switchbox, solenoid valve, manual override ---etc.) for quarter turn valves

Nutork Corp. supply the following product range:

	<p><b>NK series rack &amp; pinion type (CE-ATEX certified and PED compliant)</b></p> <p>14 models, the output torque from 9Nm(80in.lbs) to 3,920Nm(34,660in.lbs) at 6 bar air supply. ISO5211/DIN3337 for valve connection, VDI/VDE 3845(Namur) standard connection for solenoid valve and shaft top end(limit switchbox or E/P positioner), +/-5 degree stroke adjustment. 25-30um standard hard anodized treatment on actuator body and over 120um epoxy coated on end caps which meet ASTM B117 qualification(salt spread test over 1,000 hours and no corrosion).</p> <p>PTFE, Polyester, Nickel, Ceramic and Epoxy coated are available on request.</p>
	<p><b>NSF series scotch yoke type pneumatic and hydraulic actuators (CE-ATEX certified and PED compliant)</b></p> <p>The output torque from 1,660Nm(14,690in.lbs) to 226,200Nm (2,001,870in.lbs) at 6 bar air supply. Anti-corrosion painting on outer body and cylinder as standard. VDI/VDE 3845(Namur) standard connection for shaft top end(limit switchbox or E/P positioner), +/-10 degree stroke adjustment. ISO5211 standard for valve connection. PTFE coated on inner cylinder surface. Hydraulic manual override is available for big size actuator.</p>
	<p><b>NTE series electric actuator, CE approval</b></p> <p>10 models and the output torque from 18Nm(159in.lbs) to 2,000Nm(17,700in.lbs), compact design, die-casting aluminum alloy housing, alloy steel with heat treatment gear driving unit, integral wormgear &amp; drive shaft, 30% duty rating, detachable crank handle, ISO5211(option), IP68 enclosure.</p>
	<p><b>NTEII series electric actuator, CE approval</b> <b>Dual Power: 12- 24 VAC/DC or 85-265VAC/VDC, Module-in design &amp; encapsulated control pack</b></p> <p>10 models and the output torque from 18Nm(159in.lbs) to 2,000Nm(17,700in.lbs), compact design, die-casting aluminum alloy housing, alloy steel with heat treatment gear driving unit, integral wormgear &amp; drive shaft, 30% duty rating, detachable crank handle, ISO5211(option), IP68 enclosure.</p> <p>Option Functions: 1. Integral Local Control Unit. 2. Infrared non-intrusive calibration 3. LCD display(2 lines, 15 character) 4. Electronic over-torque protection 5. Electronic limitation at open &amp; close position and the others.</p>
	<p><b>NTQ electric actuator, CE approval(IP67 &amp; EExdIIBT4 enclosure)</b></p> <p>10 models, the output torque from 100Nm(885in.lbs) to 3,000Nm(26,550in.lbs), de-clutchable manual override, 2xSPDT each for open &amp; close, torque switch: 1xSPDT each for open &amp; close. space heater, self-lock, IP67 &amp; EExdIIBT4 enclosure.</p>
	<p><b>The fully range accessories(Limit Switchbox, Solenoid Valve, Declutchable Manual Override, Air Filter regulator, E/P Positioner ---etc).</b></p>
	<p><b>Dual Plate Check Valve:</b> Retainerless Type Metal Seat Valve Size : DN40-DN1000/150LB DN40-DN600/ 300LB DN40-DN300/ 600LB-2500LB Full Liner Rubber seat Valve Size : DN40-DN2000/ 125-150LB</p>

As we continue to grow and become a major supplier to the industry. **NUTORK CORP.** will add the necessary people, inventory and new product to set us apart from the rest of the pack!

## NUTORK Corp.

Head Office:  
P.O.Box 890245,Houston,TX 77289,USA  
Tel: + 1 (713) - 429 - 5458  
Fax: +1 (866) - 478 - 9624  
E-mail:nutork-usa@nutork.com  
website:www.nutork.com

China Office:  
1360(#11) Hu-Qing-Ping Road,Qing-Pu Area,  
Shanghai,China  
TEL:+86-21-5988-7103  
+86-21-5988-8436  
FAX:+86-21-5988-7203  
E-mail:nutork@nutork.com